

KEY FEATURES

- Enclosed Medical Switching Power Supply
- Remote ON/OFF Function
- Standby 5V@1A
- High Efficiency up to 92%
- With P.F.C. Function >0.94
- Ultra Compact Size: 5.5 x 3.25 x 2.48 Inches
- 3-Year Product Warranty

ELECTRICAL SPECIFICATIONS

All specifications valid at normal input voltage, full load and +25°C after warm-up time unless otherwise stated.

Model No.	MQF500E-12S	MQF500E-15S	MQF500E-24S	MQF500E-48S	
Max Output Wattage (W)	500 W				
Input	Voltage	90-264 VAC or 127-370 VDC			
	Frequency (Hz)	47-63 Hz			
	Current (Full load)	<6.3 A max. (115 VAC) / <3.15 A max. (230 VAC)			
	Inrush Current (<2ms) (Cold Start)	< 40 A max. (115 VAC) / < 80 A max. (230 VAC)			
	Leakage Current	< 0.1 mA max. (Input-Output)			
	Power Factor (at 230 VAC)	PF>0.94 at Full Load			
Output	Voltage (V.DC.)	12V	15V	24V	48V
	Voltage Accuracy	±2%			
	Voltage Adj. Range (V.DC)	±4% Output Voltage			
	Current (A) (max.)	41.5	33.3	20.8	10.41
	Line Regulation (115-264 VAC)	±0.5%			
	Load Regulation (10-100%) (typ.)	±1%			
	Minimum Load	3%			
	Maximum Capacitive Load	5,000µF	3,750µF	2,500µF	1,250µF
	Ripple & Noise (typ.)	160mV	160mV	240mV	480mV
	Efficiency (at 230 VAC)	89%	89%	91%	92%
	Hold-up Time (at 115 VAC)	8 ms min.			
Protection	Over Power Protection	Auto recovery			
	Over Voltage Protection	Auto recovery			
	Overt Temperature Protection	Auto recovery			
	Short Circuit Protection	Protection level 1 (nominal) : Continuous, Auto recovery Protection level 2 (instantaneous high current) : Latch			
Isolation	Input-Output (V.AC)	4000VAC or 5656VDC			
	Input-PE (V.AC)	2000V			
	Output-PE (V.AC)	1500V			
Environment	Operating Temperature	-30°C...+70°C (with derating)			
	Storage Temperature	-35°C...+85°C			
	Temperature Coefficient	±0.03%/°C (0~50°C)			
		±0.06%/°C (-30~0°C)			
	Altitude During Operation	5000m			
	Humidity	95% RH			
	Atmospheric Pressure	56 kPa to 106 kPa			
	MTBF	>160,000 h @ 25°C (MIL-HDBK-217F)			
Vibration	10~500Hz, 2G 10min./1cycle, 60min. each along X, Y, Z axes.				

ELECTRICAL SPECIFICATIONS

All specifications valid at normal input voltage, full load and +25°C after warm-up time unless otherwise stated.

Model No.		MQF500E-12S	MQF500E-15S	MQF500E-24S	MQF500E-48S
Physical	Dimension (L x W x H)	5.5 x 3.25 x 2.48 Inches (139.7 x 82.55 x 62.9 mm) Tolerance ± 0.5 mm			
	Weight	690 g			
Safety	Approval	Others: UL / IEC / EN 60601 3.1 st Edition & UL / IEC / EN 60950 AM2			
		15S: UL / IEC / EN 60601 3.1 st Edition (In Progress)			
EMC	Conducted and Radiated EMI	EN55011 / conducted class B, Radiated Class A			
	EMS	EN60601-1-2 4th edition			

NOTE

- Ripple & Noise are measured at 20MHz of bandwidth with ceramic 0.1uF & chemi-con KY 47uF parallel capacitor.

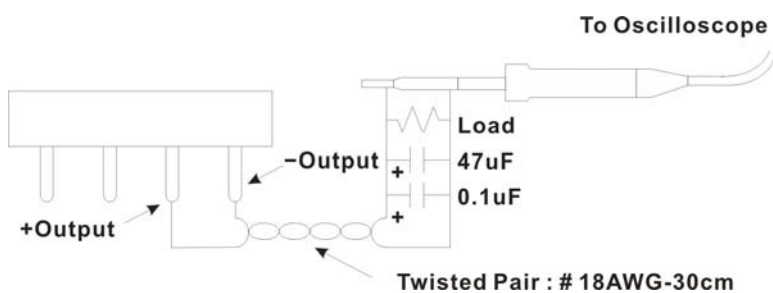

A 30cm twisted pair of no.18 AWG copper wire is connected to a 47uF and 0.1uF capacitor of proper polarity and voltage rating. The oscilloscope probe ground led should connect right to the ground ring of the probe and be as short as possible. The oscilloscope bandwidth should be at 20MHz and connected to AC ground.

- Hold-up Time measured at 90% Vout.
- Main Vout >3% Load, 12V (Aux) / 0.3A., 12V (Aux) need 0.1A Minimum Load, Auxiliary voltage output ground 10.2~13.3V
- Strongly recommend to conduct this test with DC Voltage. If customer wishes to test with AC Voltage, please disconnect all Y-Capacitors within Arch power supply.

DERATING

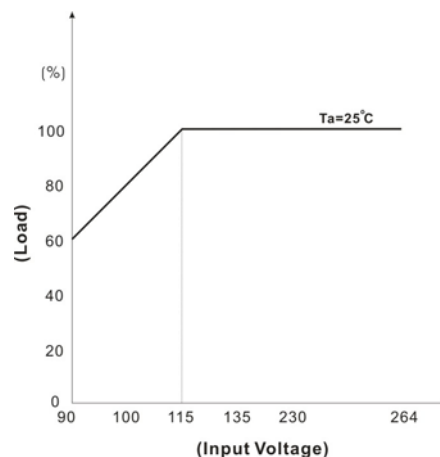
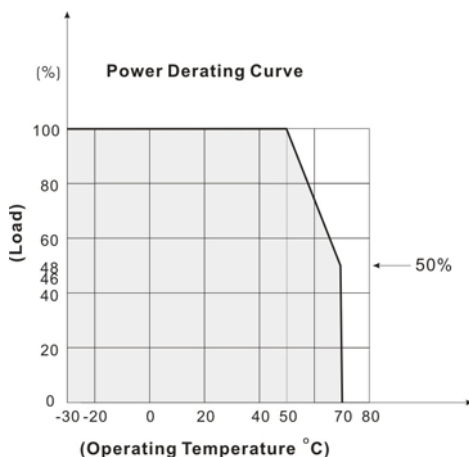

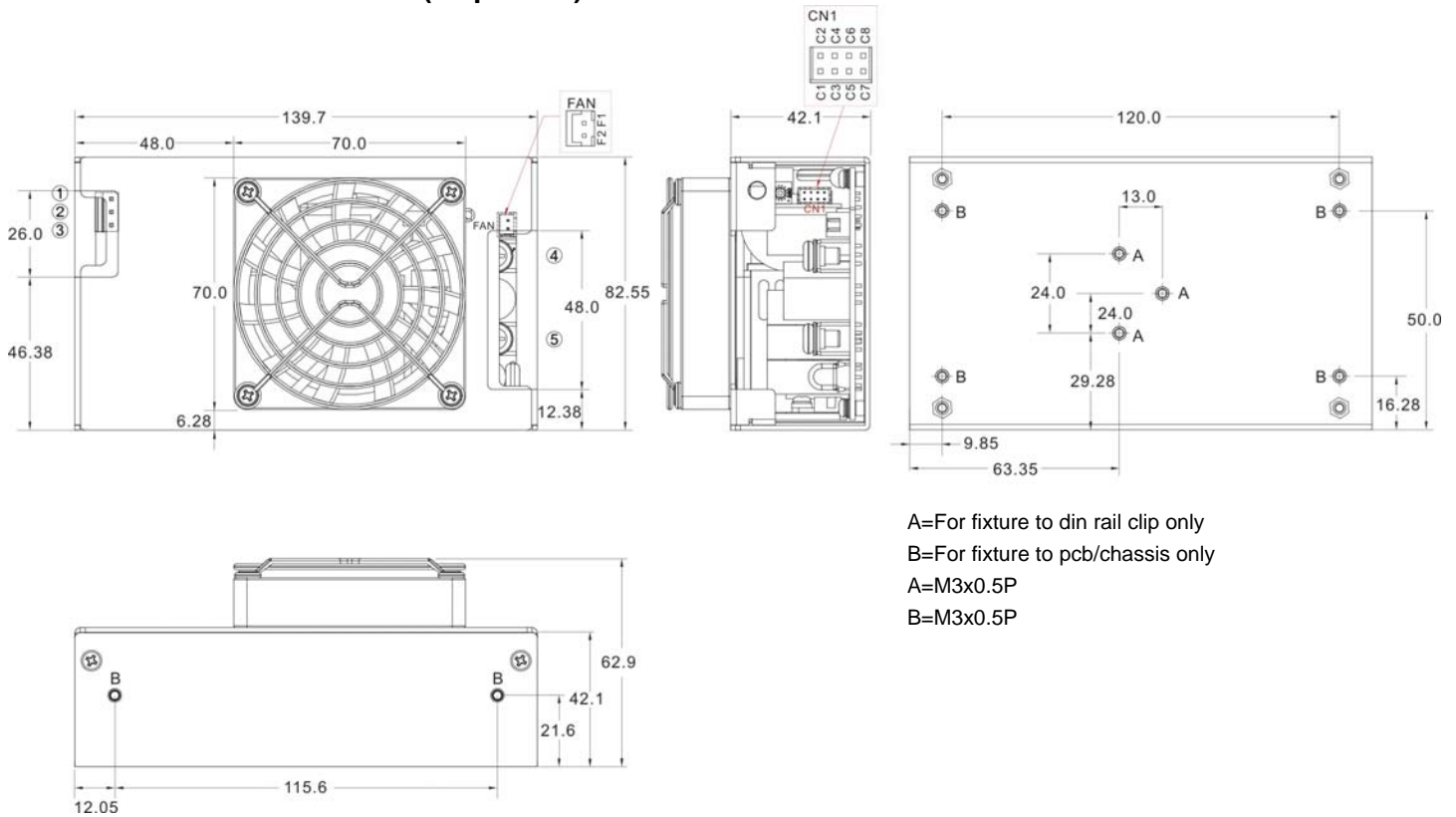
MECHANICAL DIMENSION (Top View)

ASSEMBLY INSTRUCTIONS

*U Case T=1.5mm

Customer is advised to screw into the threads no more than 2.5mm

PIN#	Single	Mating Housing	Terminal
A	PE		
AC Input Connector Pin : Alex 9397-3			
1	AC IN (N)	Alex 9396-3 or equivalent	Alex 96T Series or equivalent
2	NO PIN		
3	AC IN (L)		
DC Output Connector Pin			
4	+DC OUT	M5 Pan HD screw in 2 positions	
5	-DC OUT	Torque to 8 lbs-in(90 cNm) max.	

Connector Pin (CN1) = Cherg Weei PHD2.0 - 2x4P			
PIN#	Single	Mating Housing	Terminal
C1	-5VSB	Cherg Weei PHD2.0 - 2x4P or equivalent	Cherg Weei PHD2.0 - 2x4P or equivalent
C2	+5VSB		
C3	GND		
C4	DC OK		
C5	-RC		
C6	+RC		
C7	-S		
C8	+S		

Connector Pin (FAN) = Cherg Weei CX-W250-02			
PIN#	Single	Mating Housing	Terminal
F1	+12V	Cherg Weei	Cherg Weei
F2	GND	CS-H250-02	CS-T2501
		or equivalent	or equivalent

FUNCTION DESCRIPTION of CN1

Pin No.	Function	Description
C1	-5VSB	This pin connects to the negative terminal(-V). Return for DC-OK and -RC signal output.
C2	+5VSB	Stand by voltage output ground 4.2~5.5V, referenced to pin C1(-5VSB). The maximum load current is 1A with Fan, 0.4A without Fan..
C3	GND	This pin connects to the negative terminal(-V). Return for DC-OK and -RC signal output.
C4	DC OK	DC-OK Signal is a DC output, referenced to pin C3(DC-OK GND).
C5	-RC	This pin connects to the negative terminal(-V). Return for DC-OK and -RC signal output.
C6	+RC	Turns the output on and off by electrical or dry contact between pin C5 (-RC), Short: Power OFF, Open: Power ON. The input voltage must be less than 1V in order to disable VOUT and greater than 3.3V (up to 5V) to enable it.
C7	-S	Negative sensing. The -S signal should be connected to the negative terminal of the load. The -S and +S leads should be twisted in pair to minimize noise pick-up effect.
C8	+S	Positive sensing. The +S signal should be connected to the positive terminal of the load. The +S and -S leads should be twisted in pair to minimize noise pick-up effect.

FUNCTION MANUAL & APPLICATION NOTE
1. DC-OK Signal

Between DC-OK and GND	Output Status
3.7~6V	ON
0~1V	OFF

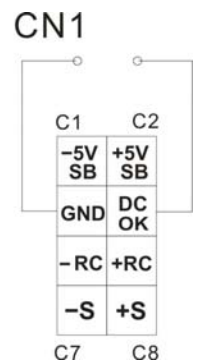
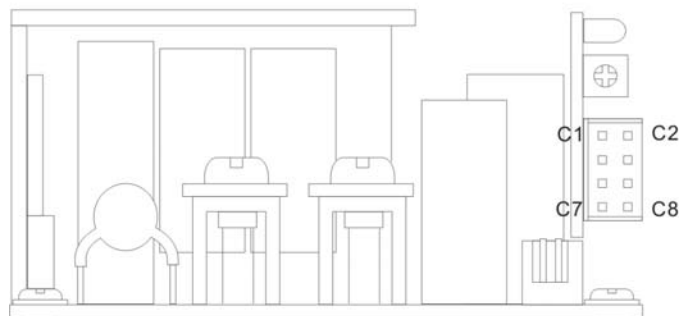
2. Remote Control

It can be turned ON/OFF by using the "Remote Control" function.

Between +RC and -RC	Output Status
SW ON (Short)	OFF
SW OFF (Open)	ON

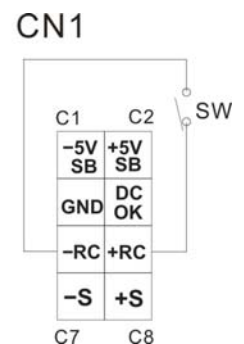
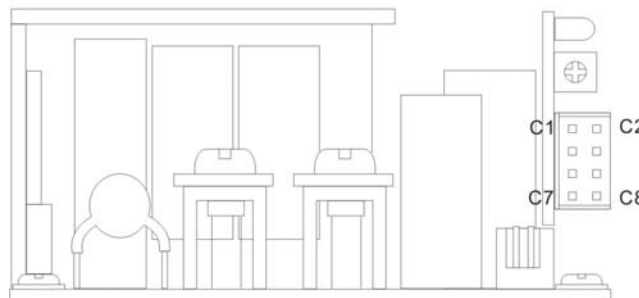
2. +S and -S Sense

Shorter wiring to each unit is recommended, as well as twisting +S and -S in pairs, as shown below

BLOCK DIAGRAM

