

KEY FEATURES

- Switching Power Module for PCB Mountable
- Fully Encapsulated Plastic Case
- Universal Input Range 90-264VAC, 47-440 Hz
- Regulated Output and Low Ripple and Low Noise
- Isolation Class II
- Small Size: 2.0 x 1.0 x 0.6 Inches
- CE, CB and UL Approval
- 3-Year Product Warranty



ELECTRICAL SPECIFICATIONS

All specifications valid at normal input voltage, full load and +25°C after warm-up time unless otherwise stated.

Model No.	AHC-3.3S-E1	AHC-5S-E1	AHC-12S-E1	AHC-15S-E1	AHC-24S-E1
Max Output Wattage (W)	4W	5W	5W	5W	5.5W
Input	Voltage				
	90-264 VAC or 120-370 VDC				
	Frequency (Hz)				
	47-440 Hz				
	Current (Full load)				
	110 mA max. (115 VAC) / 70 mA max. (230 VAC)				
Inrush Current (<2ms)					
23 A max. (115 VAC) / 46 A max. (230 VAC)					
Leakage Current					
0.75 mA max.					
External Fuse (mandatory)					
1.5 A slow blow type					
Output	Voltage (V.DC.)				
	3.3V	5V	12V	15V	24V
	Voltage Accuracy				
	±2%				
	Current (mA) max				
	1250	1000	420	333	230
	Line Regulation (LL-HL) (typ.)				
	±0.3%.				
	Load Regulation (5-100%) (typ.)				
	±0.5%.				
Minimum Load					
0%					
Maximum Capacitive Load (at 230VAC)					
13800 uF	6000 uF	1400 uF	1000 uF	170 uF	
Ripple					
<0.2% Vout +40mV max (Vp-p)					
Noise					
<0.5% Vout +50mV max (Vp-p)					
Efficiency					
68%	71%	75%	75%	77%	
Hold-up Time					
15 ms min.					
Protection	Over Power Protection				
	Hiccup technique, auto-recovery				
	Over Voltage Protection				
Zener diode clamp					
Short Circuit Protection					
Hiccup mode, indefinite (automatic recovery)					
Isolation	Input-Output (V.AC)				
3000V					
Environment	Operating Temperature				
	-40°C...+70°C (with derating)				
	Storage Temperature				
	-40°C...+85°C				
	Temperature Coefficient				
±0.02%/°C					
Humidity					
95% RH					
MTBF					
>450,000 h @ 25°C (MIL-HDBK-217F)					
Physical	Dimension (L x W x H)				
	2.0 x 1.0 x 0.6 Inches (51.2 x 25.8 x 15.4 mm) Tolerance ±0.5 mm				
	Case Material				
	Plastic resin with Fiberglass (flammability to UL 94V-0)				
Weight					
30 g					
Cooling Method					
Free air convection					
Safety	Agency Approvals				
CE, UL/cUL, CB					
EMC	EMI (Conducted & Radiated Emission)				
	EN 55032 class B				
EMS (Noise Immunity)					
EN 55024					

NOTE

1. Ripple & Noise are measured at 20MHz of bandwidth with 0.1uF & 47uF parallel capacitor.
2. It's necessary Varistor 14S471K at L / N input side in parallel.
3. Safety approvals cover frequency 47-63 Hz.
4. Please refer to our PDF file "AC-DC Application" on our website: www.archcorp.com.tw

OUTPUT NOISE

The output noise is measured with 47μF tantalum capacitor and 0.1μF ceramic capacitor across output.

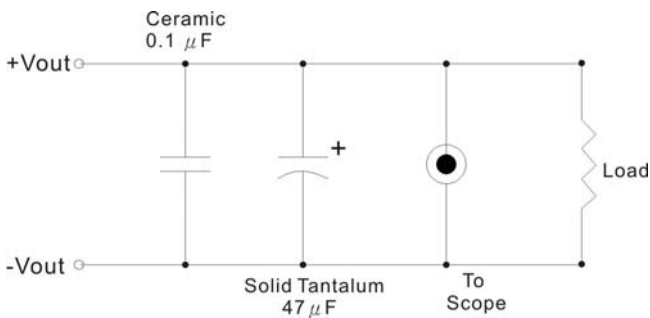

DERATING

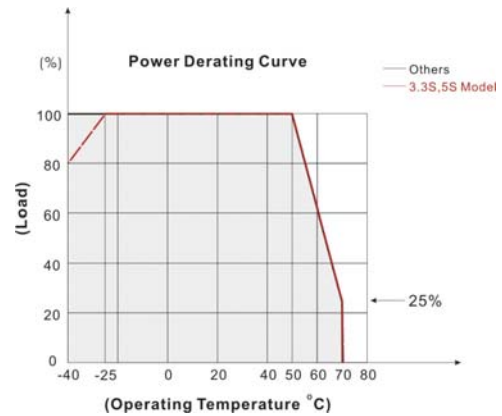

MECHANICAL DIMENSION (Top View)

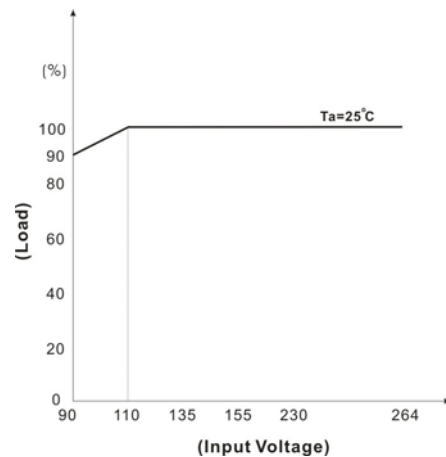
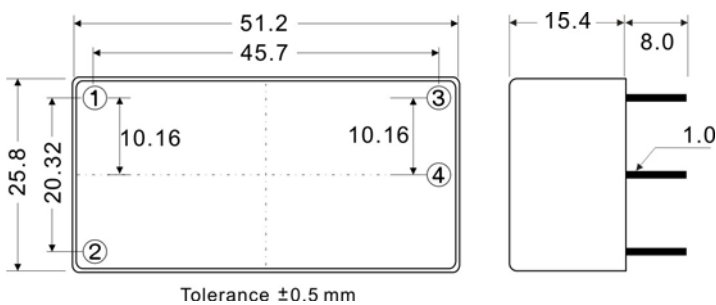

PIN#	Single
1	AC IN (N)
2	AC IN (L)
3	+DC OUT
4	-DC OUT

BLOCK DIAGRAM

Single Output

