

KEY FEATURES

- Switching Power Modules for PCB Mounting
- Fully Encapsulated Plastic Case
- Universal Input Range 90-264VAC, 47-440 Hz
- Regulated Output and Low Ripple and Low Noise
- Isolation Class II
- -40°C Starting
- Small Size as ASC 30Watt and 40Watt Higher Wattage
- CE, CB and UL Approval
- 3-Year Product Warranty



ELECTRICAL SPECIFICATIONS

Model No. (Single Output)	AJC-3.3S	AJC-5S	AJC-9S	AJC-12S	AJC-15S	AJC-24S	
Max output wattage (W)	26.4W	40W	40W	40W	40W	40W	
Output	Voltage (V.DC.)	3.3V	5V	9V	12V	15V	24V
	Current (mA) max	8000	8000	4444	3333	2666	1667
	Voltage set accuracy	±3%	±2%	±2%	±2%	±2%	±2%
	Line regulation (typ.)	0.5%	0.5%	0.5%	0.5%	0.5%	0.5%
	Load regulation (1-100%) (typ.)	1%	1%	1%	1%	1%	1%
	Minimum load	1%	1%	1%	1%	1%	1%
	Maximum Capacitive Load (at 230VAC)	60000 uF	40000 uF	7200 uF	8600 uF	6600 uF	1400 uF
	Efficiency (typ.)	74%	81%	82%	84%	83%	83%

Model No. (Dual Output)	AJC-5D		AJC-12D		AJC-15D		
Max output wattage (W)	40W		40W		40W		
Output	Output 1	Output 2	Output 1	Output 2	Output 1	Output 2	
	Voltage (V.DC.)	+5V	-5V	+12V	-12V	+15V	-15V
	Current (mA) max	4000	4000	1666	1666	1333	1333
	Voltage set accuracy	±2%		±2%		±2%	
	Line regulation (typ.)	0.5%		0.5%		0.5%	
	Load regulation (10-100%) (typ.)	1% (symmetric load)		1% (symmetric load)		1% (symmetric load)	
	Cross regulation (15-100%) (typ.)	±5%		±5%		±5%	
	Minimum load	10%		10%		10%	
	Maximum Capacitive Load (at 230VAC)	±12000 uF		±4400 uF		±1000 uF	
	Efficiency (typ.)	81%		83%		83%	

Model No. (Dual Output)	AJC-5S12S		AJC-5S24S		
Max output wattage (W)	40W		40W		
Output	Output 1	Output 2	Output 1	Output 2	
	Voltage (V.DC.)	5V	12V	5V	24V
	Current (mA) max	5000	1250	5000	625
	Voltage set accuracy	±3%	±5%	±3%	±5%
	Line regulation (typ.)	0.5%	5%	0.5%	5%
	Load regulation (25-100%) (typ.)	2% (symmetric load)	6% (symmetric load)	2% (symmetric load)	6% (symmetric load)
	Cross regulation (25-100%) (typ.)	±1%	±7%	±1%	±7%
	Minimum load	25%		25%	
	Maximum Capacitive Load (at 230VAC)	10000 uF	470 uF	10000 uF	400 uF
	Efficiency (typ.)	82%		82%	

ELECTRICAL SPECIFICATIONS

Model No. (Triple Output)	AJC-5S12D			AJC-5S15D		
Max output wattage (W)	40W			40W		
Output	Output 2	Output 3	Output 1	Output 2	Output 3	
	Voltage (V.DC.)	+12	-12	5	+15	-15
	Current (mA) max	600	600	5000	500	500
	Voltage set accuracy	±5%		±3%	±5%	
	Line regulation (typ.)	5%		0.5%	5%	
	Load regulation (25-100%) (typ.) (symmetric load)	7%		3%	7%	
	Cross regulation (typ.)	±7%		±3%	±7%	
	Minimum load	25%			25%	
	Maximum Capacitive Load	780 uF		10000 uF	900 uF	
	Efficiency (typ)	80%			81%	

ELECTRICAL SPECIFICATIONS

Input	Voltage	90-264 VAC or 100-375 VDC
	Frequency (Hz)	47-440 Hz
	Current (Full load)	860 mA max. (115 VAC) / 460 mA max. (230 VAC)
	Inrush current (<2ms)	30 A max. (115 VAC) / 50 A max. (230 VAC)
	Leakage Current	0.75 mA max.
Output	Maximum capacitive load	470-23,000µF depending on model
	Ripple & Noise	3.3V : 50mV of Vout / others : 1% of Vout
	Hold-up time	10 ms min.
Protection	Over current protection	Above 105% rated output power
	Over voltage protection	Zener diode clamp
	Short circuit protection	Hiccup mode, indefinite (automatic recovery)
	OTP	100°C
Isolation	Input-Output (V.AC)	3000V
Environment	Operating temperature	-40°C...+70°C (Case Temperature max. +95°C)
	Storage temperature	-40°C...+85°C
	Temperature coefficient	0.01%/°C
	Humidity	95% RH
	MTBF	200,000 h~400,000 h @ 25°C
Physical	Dimension (L x W x H)	3.52 x 2.52 x 0.98 Inches (89.5 x 64.1 x 25.0 mm) Tolerance ±0.5 mm
	Case Material	Plastic resin (flammability to UL 94V-0)
	Weight	280 g
	Cooling method	Free air convection
Safety & EMC	Agency Approvals	CE, UL/cUL, CB
	EMI (Conducted & Radiated Emission)	EN 55032 class B
	EMS (Noise Immunity)	EN 55024

NOTE

1. All specifications valid at normal input voltage, full load and +25°C after warm-up time unless otherwise stated.
2. Ripple & Noise are measured at 20MHz of bandwidth with 0.1uF & 47uF parallel capacitor.
3. It's recommended to add Varistor 14S471K at L / N input side in parallel.
4. It's necessary 10R / 15φ thermistor at L input side in series connection.
5. Please refer to our PDF file "AC-DC Application" on our website: www.archcorp.com.tw

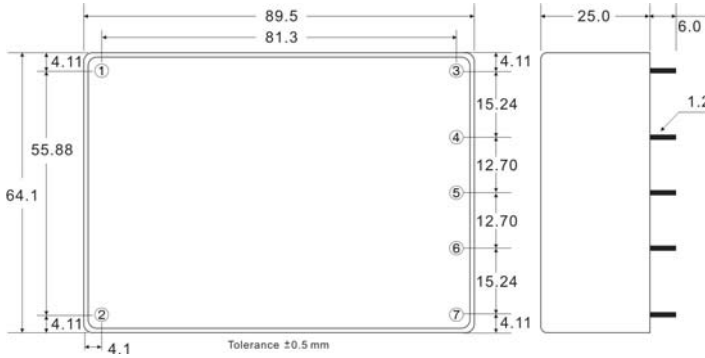
MECHANICAL DIMENSION (Top View)

PIN#	Single	Dual	5S/12S 5S/24S	Triple
1	AC IN (L)	AC IN (L)	AC IN (L)	AC IN (L)
2	AC IN (N)	AC IN (N)	AC IN (N)	AC IN (N)
3	+DC OUT	+DC OUT	+OUT2	+DC OUT
4	NO PIN	NO PIN	+OUT1	+5V
5	-DC OUT	COMMON	+OUT2 RTN	COMMON
6	NO PIN	NO PIN	+OUT1 RTN	+5 RTN
7	NOCONNECT	-DC OUT	NO PIN	-DC OUT

BLOCK DIAGRAM

Single Output

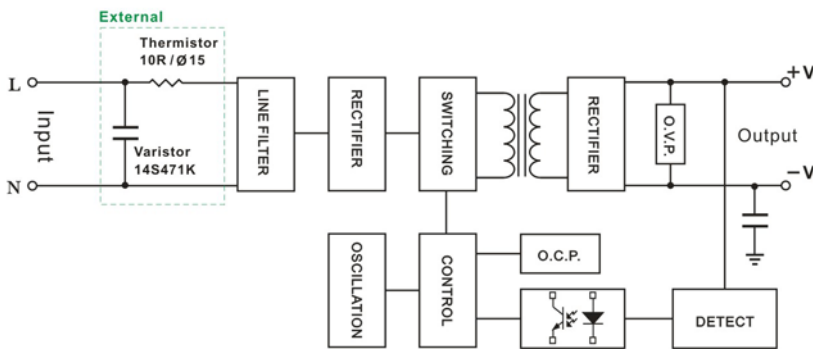
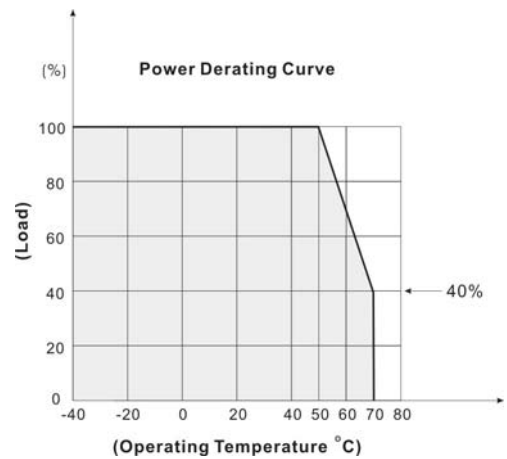
DERATING

Dual Output

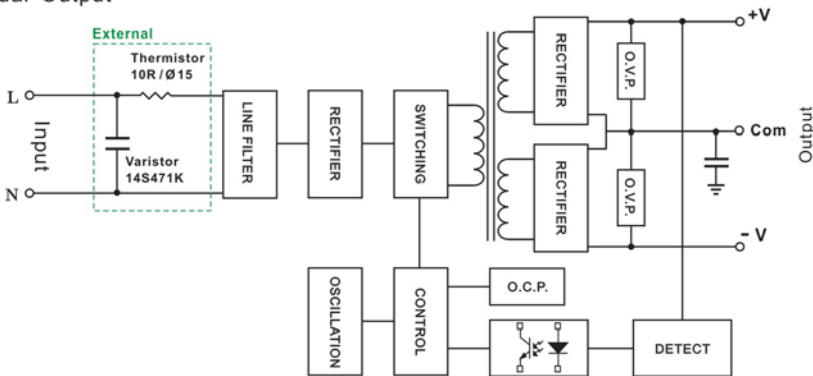

Triple Output

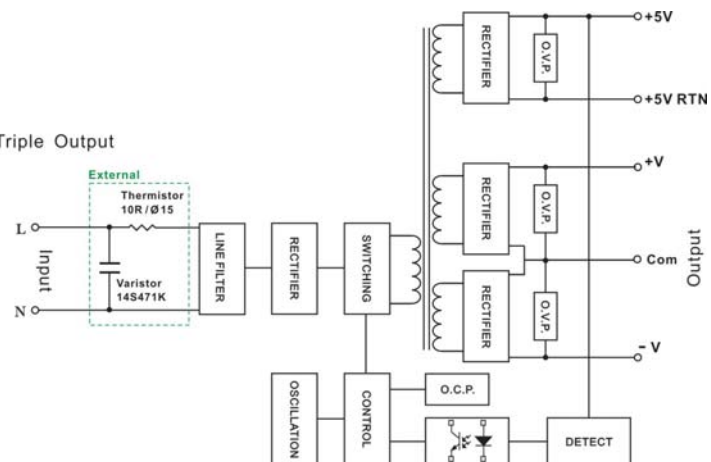

SCREW TERMINAL

AJC-A2

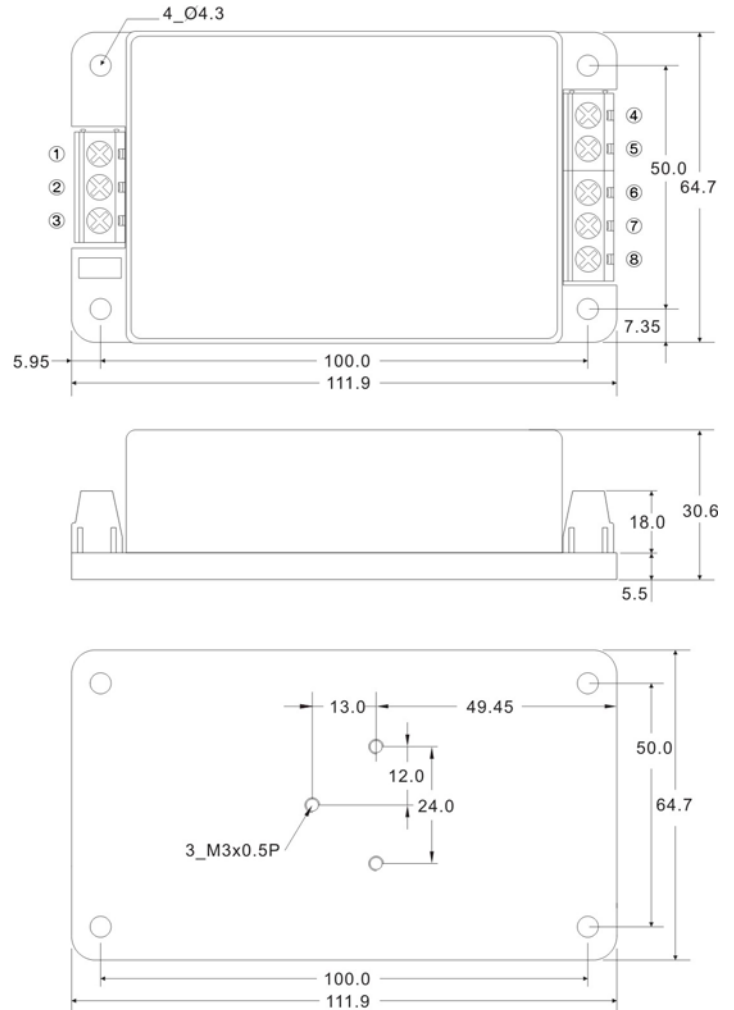

PIN#	Single	Dual	5S/12S 5S/24S	Triple
1	NOCONNECT	NOCONNECT	NOCONNECT	NOCONNECT
2	AC IN (L)	AC IN (L)	AC IN (L)	AC IN (L)
3	AC IN (N)	AC IN (N)	AC IN (N)	AC IN (N)
4	+DC OUT	+DC OUT	+OUT2	+DC OUT
5	NOCONNECT	NOCONNECT	+OUT1	+5V OUT
6	-DC OUT	COMMON	+OUT2 RTN	COMMON
7	NOCONNECT	NOCONNECT	+OUT1 RTN	+5V RTN
8	NOCONNECT	-DC OUT	NOCONNECT	-DC OUT