

RSVR-78Mv3

0.5A Non-Isolated, regulated DC/DC Converter

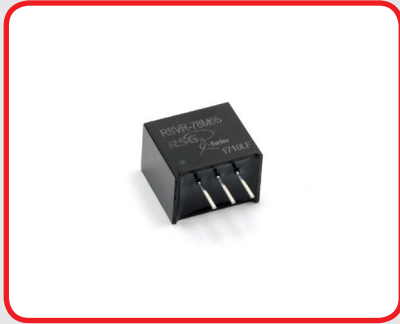

Picture similar

RoHS

- 3 Pin SIL Package
- Wide Input Range
- Step-down switching
- Full SMD Technology
- Efficiency up to 95%
- Operating Temperature Range -40°C ~ +85°C
- Continuous Short Circuit Protection (self-recovery)
- Pin-out compatible with LM78MXX three terminals positive Regulator
- Non Conductive Black Plastic Case

Output Specifications	
Voltage Accuracy	±2% typ., ±3 ~ 4% max.
Output Voltage Adjustability (Trim)	–
Maximum Output Current	500mA or -300mA max.
Line Regulation	±0.2% typ., ±0.4% max.
Load Regulation	from 10% to 100% Load: ±0.3-0.6% typ. –
Short Circuit Protection	Continuous, self-recovery
Ripple & Noise (20 MHz bandwidth)	20mV typ., 75mV pk-pk max.
Temperature Coefficient	±0.03%/°C
Capacitor Load	See table
Transient Recovery Time	250µs max. 1ms max.
Transient Response	

Input Specifications	
Voltage Range	See table
Start-up Time	
No-Load/Full-Load Input Current	See table
Input Filter	
Input Reflected Ripple Current	–
Remote ON	–
Remote OFF	–
OFF Stand By Current	–
OFF Idle Current	–

General Specifications	
Efficiency	See table typ.
Switching Frequency	550 ~ 850kHz max.
Humidity	95% rel H
Reliability Calculated MTBF	>2.0Mhrs (MIL-HDBK-217 f)
Safety Standard(s)	IEC/EN60950-1 (designed to meet)

Environmental Specifications	
Operating Temperature Range	-40°C ~ +85°C (see Derating Curve)
Maximum Case Temperature	
Storage Temperature	-55°C ~ +125°C
Cooling	Natural Convection

Physical Specifications	
Case Material	Black flame-retardant, heat-resistant plastic (UL94 V-O)
Pin Material	–
Potting Material	–
Weight	1.8g typ.
Case Dimensions	0.46" x 0.29" x 0.40"

Absolute Maximum Ratings (1)	
Input Surge Voltage (100 ms)	
Soldering Temperature (2)	260°C max.

EMC Specifications	
Radiated / Conducted Emissions	EN55032 Class B see EMI Filter
ESD	IEC /EN61000-4-2 Perf.Criteria B
RS	IEC 61000-4-3 Perf.Criteria A
EFT	IEC 61000-4-4 Perf.Criteria B
SURGE	IEC 61000-4-5 Perf.Criteria B
CS	IEC 61000-4-6 Perf.Criteria A
PFMF	–

(1) These are stress ratings. Exposure of devices to any of these conditions may adversely affect long-term reliability. (2) 1.5 mm from case 10 sec max.

All specifications typical at TA = 25 °C, nominal input voltage and full load unless otherwise specified.

The information and specification contained in this data sheet are believed to be correct at time of publication. However RSG accepts no responsibility for consequences arising from printing errors or inaccuracies. **Specifications are subject to change without notice.**

Number structure RSVR/RTVR Series

RSVR	-	78	F	05	D	(v3)
Name / package	Compatibility	Usage / Amps	Voltage out	Int. Code		
RSVR = SIL3 RTVR = DIL10-SMD	78 = LM78xx	M = Mid-Amp (0.5 A) F = Full-Amp (1.0 A) D = Double-Amp (2.0 A) W = Wide-Input (0.5 A)	00 = 1.5 V 01 = 1.8 V 02 = 2.5 V ... 15 = 15 V	Logistics Code		

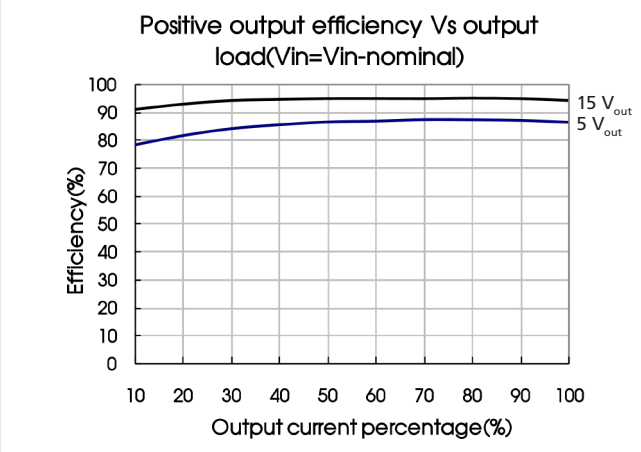
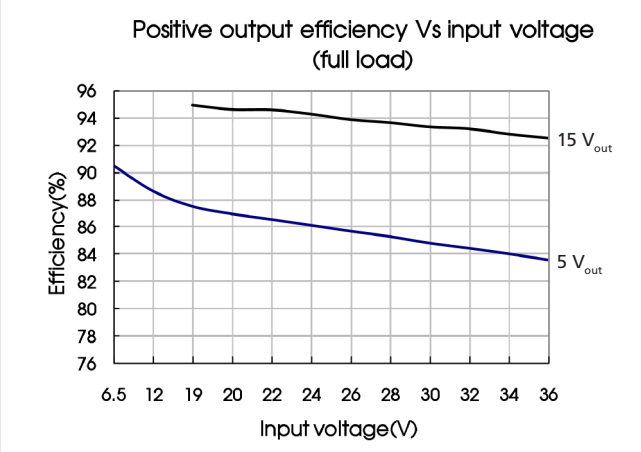
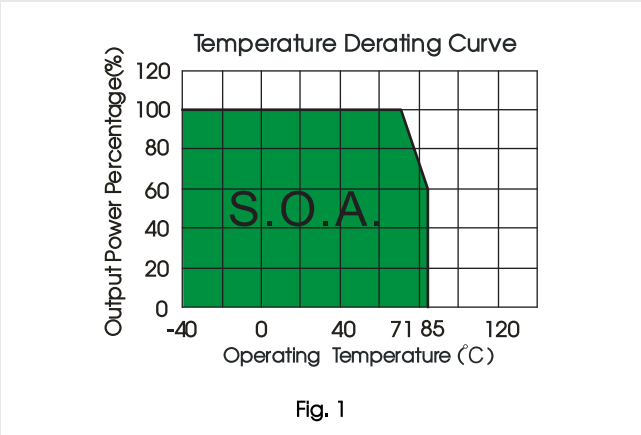

Model Selection Guide

Model Number	Input Voltage (VDC)	Output		Efficiency (%/Typ.) (Min. Vin) / (Max. Vin) @ Full Load	Max. Capacitive Load (µF)
	Nominal (Range)	Output Voltage (VDC)	Max. Output Current (mA)		
RSVR-78M03v3	24 (4.75~36)	3.3	500	86/80	680
RSVR-78M05v3	24 (6.5~36)	5	500	90/84	680
	12 (7~31)	-5	-300	80/81	330
RSVR-78M09v3	24 (12~36)	9	500	93/90	680
RSVR-78M12v3	24 (15~36)	12	500	94/91	680
	12 (8~24)	-12	-150	84/85	330
RSVR-78M15v3	24 (19~36)	15	500	95/93	680
	12 (8~21)	-15	-150	85/87	330

Note: For input voltage higher than 30 VDC, a 22µF/50V input capacitor is required.

The models listed above are standard types. If you need special specifications or have questions regarding packing (Tube or Tape & Reel) or need application support, please contact our specialists: sales@rsg-electronic.de or +49 69-984047-0

Negative output efficiency Vs input voltage (full load)

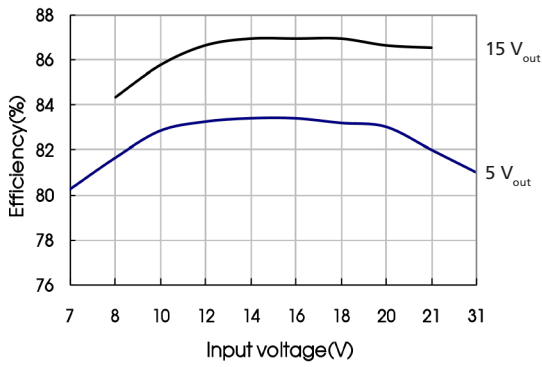

Negative output efficiency Vs output load (Vin=Vin-nominal)

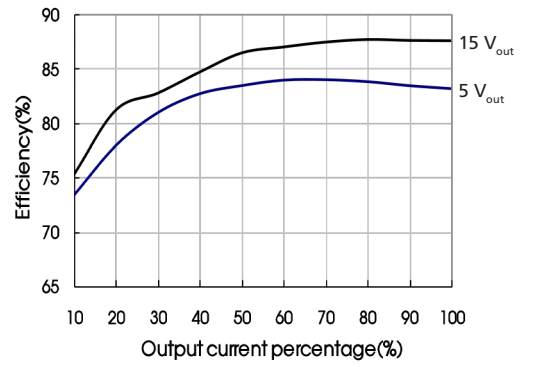

Typical Application Circuit

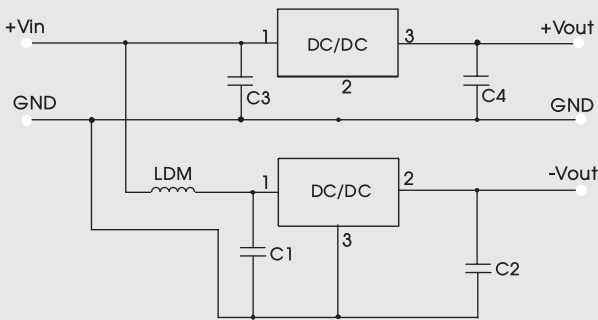
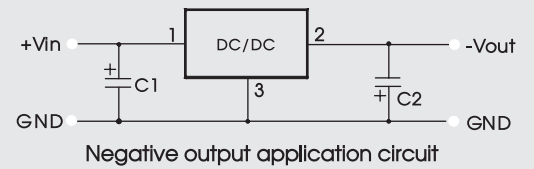
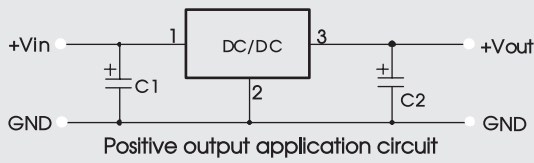
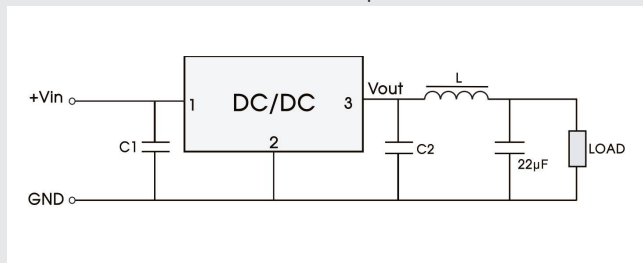

Fig. 3 Positive and Negative output parallelling application circuit

Part No.	C1/C3 (ceramic capacitor)	C2/C4 (ceramic capacitor)
RSVR-78M03v3	10μF/50V	22μF/10V
RSVR-78M05v3		22μF/10V
RSVR-78M09v3		22μF/16V
RSVR-78M12v3		22μF/25V
RSVR-78M15v3		22μF/25V
RSVR-78M15v3		22μF/25V

- Note:
1. C1 and C2 (C3 and C4) are required and should be connected close to the pin terminal of the module.
 2. For capacitance of C1 and C2 (C3 and C4) refer to table, it can be increased properly if required, and tantalum or low ESR electrolytic capacitors may also suffice.
 3. When the products used as the circuit like figure 3, an inductor named as LDM up to 10μH is recommended in the circuit to reduce the mutual interference.
 4. Cannot be used in parallel for output and hot swap.
 5. To reduce the output ripple further, it is suggested to connect a "LC" filter at the output terminal, and recommended value of L is 10μH-47μH.

Positive Output



Negative Output

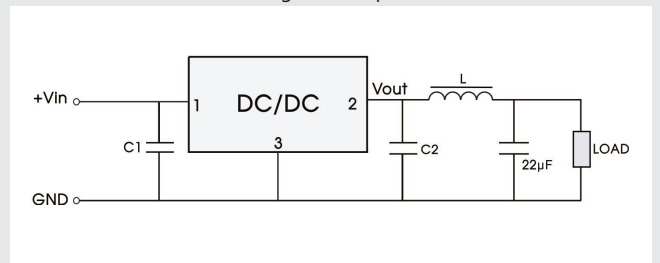

EMC solution-recommended circuit

Positive and negative Output

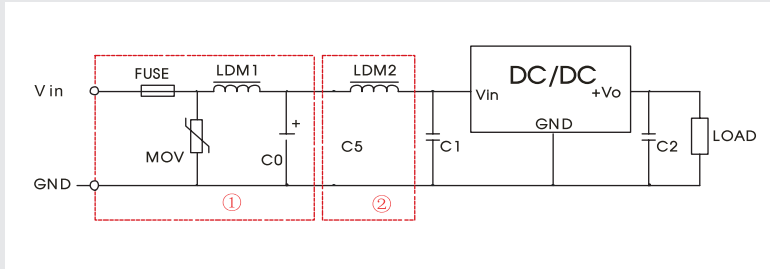

Parameter description

FUSE	Selected based on the actual input current from the customer
MOV	S20K30
LDM1	82 μ H
C0	680 μ F/50V
C1/C2	Refer to Sheet 1
C5	4.7 μ F/50V
LDM2	12 μ H

Note: Part ① in the Fig. is for EMS test, part ② is for EMI filtering; parts ① and ② can be added based on actual requirement.

Mechanical Specifications

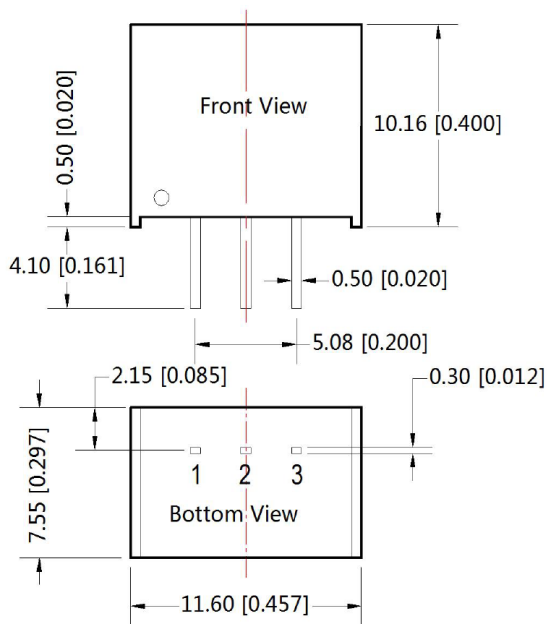

THIRD ANGLE PROJECTION

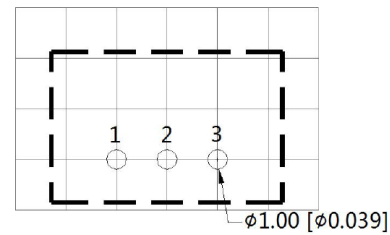

Note : Grid 2.54*2.54mm

Note:
Unit :mm[inch]
Pin section tolerances:±0.10[±0.004]
General tolerances:±0.25[±0.010]

Pin Connections		
Pin Number	Positive Output	Negative Output
1	+V Input	+V Input
2	GND	-V Output
3	+V Output	GND

Notes

1. The maximum capacitive load offered were tested at input voltage range and full load;
2. Unless otherwise specified, parameters in this datasheet were measured under the conditions of Ta=25 , humidity<75%RH with nominal input voltage and rated output load.