



P-DUKE POWER

FED30W Series

DC-DC Converter
Up to 30 Watts

3
YEARS
WARRANTY

ROHS
COMPLIANT

REACH
COMPLIANT



Automation



Datacom



IPC



Industry



Measurement



Telecom



Automobile



Boat



Charger



Medical



PV



Railway

UL US CB CE

1600
VDC
Isolation
Voltage

4 : 1
Wide
Input
Range

6
sided
Shielding

NO
Min. Load
Required

REMOTE
ON
OFF

OCP

OTP

OVP

SCP

UVP

PART NUMBER STRUCTURE

FED30	-	48	S	05	W	-	N	HC
Series Name		Input Voltage (VDC)	Output Quantity	Output Voltage (VDC)	Input Range		Remote Control Option	Assembly Option
		24:9~36 48:18~75	S:Single D: Dual	1P5: 1.5 2P5: 2.5 3P3: 3.3 05: 5 5P1: 5.1 12: 12 15: 15 05: ±5 12: ±12 15: ±15	4:1		□: Positive logic N: Negative logic	□: None HC: Heat-sink with Clamp

TECHNICAL SPECIFICATION All specifications are typical at nominal input, full load and 25°C unless otherwise noted

Model Number	Input Range	Output Voltage	Output Current @Full Load	Input Current @ No Load	Efficiency	Maximum Capacitor Load
	VDC	VDC	A	mA	%	μF
FED30-24S1P5W	9 ~ 36	1.5	8.5	70	80	20000
FED30-24S2P5W	9 ~ 36	2.5	8	70	83	20000
FED30-24S3P3W	9 ~ 36	3.3	7.5	70	86	20000
FED30-24S05W	9 ~ 36	5	6	105	88	14400
FED30-24S5P1W	9 ~ 36	5.1	6	105	88	14400
FED30-24S12W	9 ~ 36	12	2.5	20	89	3000
FED30-24S15W	9 ~ 36	15	2	30	89	2000
FED30-24D05W	9 ~ 36	±5	±3	90	88	±3000
FED30-24D12W	9 ~ 36	±12	±1.25	25	87	±2000
FED30-24D15W	9 ~ 36	±15	±1	25	87	±1300
FED30-48S1P5W	18 ~ 75	1.5	8.5	30	80	20000
FED30-48S2P5W	18 ~ 75	2.5	8	45	84	20000
FED30-48S3P3W	18 ~ 75	3.3	7.5	45	86	20000
FED30-48S05W	18 ~ 75	5	6	65	88	14400
FED30-48S5P1W	18 ~ 75	5.1	6	65	88	14400
FED30-48S12W	18 ~ 75	12	2.5	60	90	3000
FED30-48S15W	18 ~ 75	15	2	50	91	2000
FED30-48D05W	18 ~ 75	±5	±3	50	88	±3000
FED30-48D12W	18 ~ 75	±12	±1.25	15	88	±2000
FED30-48D15W	18 ~ 75	±15	±1	15	88	±1300

INPUT SPECIFICATIONS

Parameter	Conditions	Min.	Typ.	Max.	Unit
Operating input voltage range	24Vin(nom)	9	24	36	VDC
	48Vin(nom)	18	48	75	
Start up voltage	24Vin(nom)			9	VDC
	48Vin(nom)			18	
Shutdown voltage	24Vin(nom)	7	8	8.8	VDC
	48Vin(nom)	15	16	17.5	
Start up time	Constant resistive load	Power up	30		ms
		Remote ON/OFF	30		
Input surge voltage	100 ms, max.			50 100	VDC
Input filter				Pi type	
Remote ON/OFF	Referred to -Vin pin	Positive logic (Standard)	DC-DC ON	Open or 3 ~ 12VDC	
			DC-DC OFF	Short or 0 ~ 1.2VDC	
		Negative logic (Option)	DC-DC ON	Short or 0 ~ 1.2VDC	
			DC-DC OFF	Open or 3 ~ 12VDC	
		Input current of Ctrl pin	-0.5	+0.5	mA
		Remote off input current		3.0	mA

OUTPUT SPECIFICATIONS						
Parameter	Conditions		Min.	Typ.	Max.	Unit
Voltage accuracy			-1.0		+1.0	%
Line regulation	Low Line to High Line at Full Load	Others	-0.2		+0.2	%
		Dual 5Vout	-0.25		+0.25	%
Load regulation	No Load to Full Load	Single	-0.5		+0.5	%
		Dual	-1.0		+1.0	%
Cross regulation	Asymmetrical load 25%/100% FL	Dual	-5.0		+5.0	%
Voltage adjustability	Single output		-10		+10	%
Ripple and noise	20MHz bandwidth	Others		100		mVp-p
	With a 1 μ F/50V MLCC	12Vout, 15Vout		150		
Temperature coefficient			-0.02		+0.02	%/°C
Transient response recovery time	25% load step change			250		μ s
Over voltage protection	Zener diode clamp	1.5Vout		2.0		VDC
		2.5Vout		3.3		
		3.3Vout		3.9		
		5Vout, 5.1Vout		6.2		
		12Vout		15		
		15Vout		18		
Over load protection	% of Iout rated			150		%
Short circuit protection			Continuous, automatic recovery			

GENERAL SPECIFICATIONS						
Parameter	Conditions		Min.	Typ.	Max.	Unit
Isolation voltage	1 minute	Input to Output Input (Output) to Case	1600 1600			VDC
Case grounding			Connect case to -Vin with decoupling Y Cap			
Isolation resistance	500VDC		1			G Ω
Isolation capacitance					1500	pF
Switching frequency			387	430	473	kHz
Safety approvals	IEC /UL/ EN60950-1		UL:E193009 CB:UL(Demko)			
Case material			Nickel-coated copper			
Base material			FR4 PCB			
Potting material			Epoxy (UL94 V-0)			
Weight			30.5g (1.07oz)			
MTBF	MIL-HDBK-217F, Full load		1,288 x 10 ⁶ hrs			

ENVIRONMENTAL SPECIFICATIONS						
Parameter	Conditions		Min.	Typ.	Max.	Unit
Operating ambient temperature	Without derating With derating		-40 +50		+50 +85	°C
Maximum case temperature					+105	°C
Over temperature protection				115		°C
Storage temperature range			-55		+125	°C
Thermal impedance	Without heat-sink With heat-sink			12 10		°C/W
Thermal shock			MIL-STD-810F			
Vibration			MIL-STD-810F			
Relative humidity			5% to 95% RH			

EMC SPECIFICATIONS

Parameter	Conditions	Level
EMI	EN55032 With external components	Class A
ESD	EN61000-4-2 Air $\pm 8kV$ and Contact $\pm 6kV$	Perf. Criteria A
Radiated immunity	EN61000-4-3 10 V/m	Perf. Criteria A
Fast transient	EN61000-4-4 $\pm 2kV$ 24VDC input With an external input filter capacitor (Nippon chemi-con KY series, 330 μF /50V) 48VDC input With an external input filter capacitor (Nippon chemi-con KY series, 220 μF /100V)	Perf. Criteria A
Surge	EN61000-4-5 $\pm 1kV$ 24VDC input With an external input filter capacitor (Nippon chemi-con KY series, 330 μF /50V) 48VDC input With an external input filter capacitor (Nippon chemi-con KY series, 220 μF /100V)	Perf. Criteria A
Conducted immunity	EN61000-4-6 10 Vr.m.s	Perf. Criteria A
Power frequency magnetic field	EN61000-4-8 100A/m continuous; 1000A/m 1 second	Perf. Criteria A

CAUTION: This power module is not internally fused. An input line fuse must always be used.

CHARACTERISTIC CURVE

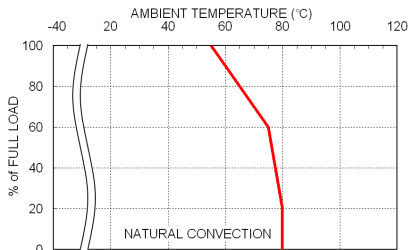

FED30-48S05W Derating Curve

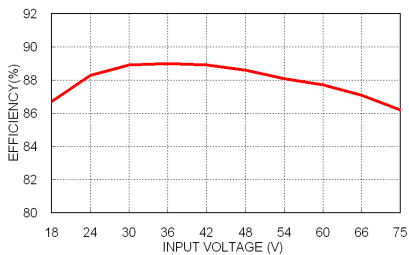

FED30-48S05W Efficiency vs. Input Voltage

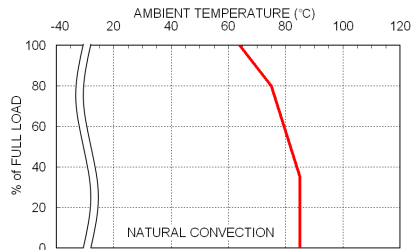

FED30-48S05W Derating Curve With Heat-sink

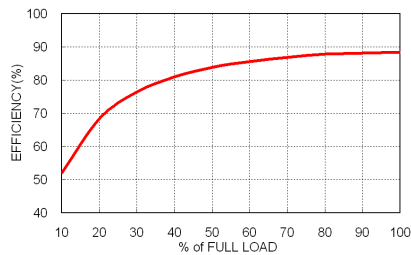

FED30-48S05W Efficiency vs. Output Load

FUSE CONSIDERATION

This power module is not internally fused. An input line fuse must always be used.

This encapsulated power module can be used in a wide variety of applications, ranging from simple stand-alone operation to an integrated part of sophisticated power architecture.

To maximum flexibility, internal fusing is not included; however, to achieve maximum safety and system protection, always use an input line fuse.

The input line fuse suggest as below :

Model	Fuse Rating (A)	Fuse Type
FED30-24S□□W · FED30-24D□□W	6.3	Slow-Blow
FED30-48S□□W · FED30-48D□□W	3.15	Slow-Blow

The table based on the information provided in this data sheet on inrush energy and maximum DC input current at low Vin.

MECHANICAL DRAWING

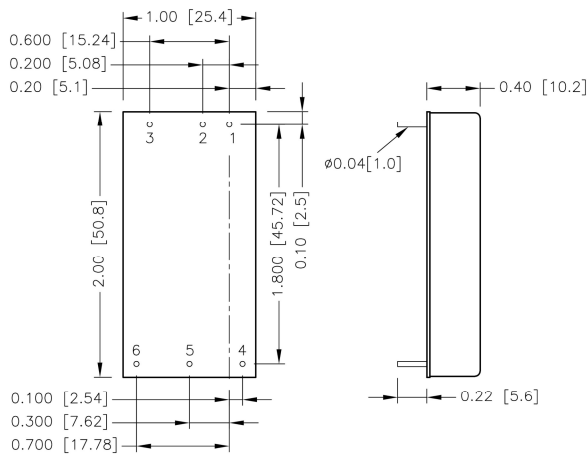

BOTTOM VIEW

PIN CONNECTION

PIN	SINGLE	DUAL
1	+Vin	+Vin
2	-Vin	-Vin
3	Ctrl	Ctrl
4	+Vout	+Vout
5	-Vout	Common
6	Trim	-Vout

1. All dimensions in inch [mm]
2. Tolerance :x.xx±0.02 [x.x±0.5]
x.xxx±0.01 [x.xx±0.25]
3. Pin pitch tolerance ±0.01 [0.25]
4. Pin dimension tolerance ±0.004[0.10]

HEAT-SINK OPTIONS

-HC (Heat-sink with clamps)

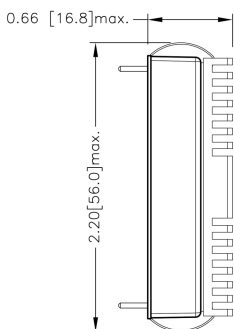

* All dimensions in inch [mm]

RECOMMENDED PAD LAYOUT

Standard

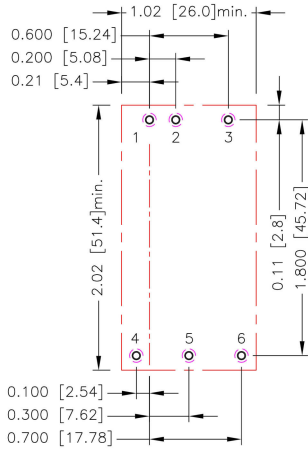

-HC

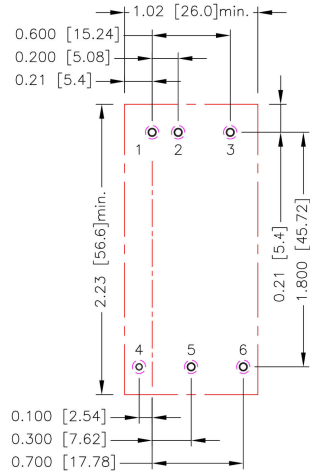

All dimensions in inch[mm]
 Pad size(lead free recommended)
 Through hole 1.2.3.4.5.6: $\Phi 0.051$ [1.30]
 Top view pad 1.2.3.4.5.6: $\Phi 0.064$ [1.63]
 Bottom view pad 1.2.3.4.5.6: $\Phi 0.102$ [2.60]

THERMAL CONSIDERATIONS

The power module operates in a variety of thermal environments. However, sufficient cooling should be provided to help ensure reliable operation of the unit. Heat is removed by conduction, convection, and radiation to the surrounding Environment. Proper cooling can be verified by measuring the point as the figure below. The temperature at this location should not exceed "Maximum case temperature". When Operating, adequate cooling must be provided to maintain the test point temperature at or below "Maximum case temperature". You can limit this Temperature to a lower value for extremely high reliability.

- Thermal test condition with vertical direction by natural convection (20LFM).

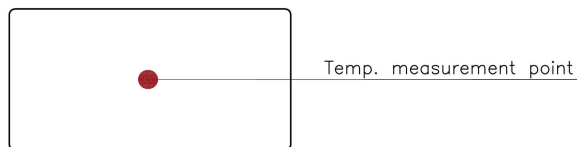

TOP VIEW

OUTPUT VOLTAGE ADJUSTMENT

Output voltage set point adjustment allows the user to increase or decrease the output voltage set point of the module. This is accomplished by connecting an external resistor between the Trim pin and either the +Vout or -Vout pins. With an external resistor between the Trim and -Vout, the output voltage set point increases. With an external resistor between the Trim and +Vout, the output voltage set point decreases. The external Trim resistor needs to be at least 1/16W of rated power.

EXTERNAL OUTPUT TRIMMING

Output can be externally trimmed by using the method shown below.

Trim-up

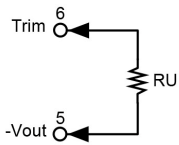
 S1P5W

ΔV (%)	1	2	3	4	5	6	7	8	9	10
Vout (V)	1.515	1.530	1.545	1.560	1.575	1.590	1.605	1.620	1.635	1.650
RU (k Ω)	4.578	2.065	1.227	0.808	0.557	0.389	0.270	0.180	0.110	0.054

 S2P5W

ΔV (%)	1	2	3	4	5	6	7	8	9	10
Vout (V)	2.525	2.550	2.575	2.600	2.625	2.650	2.675	2.700	2.725	2.750
RU (k Ω)	37.076	16.675	9.874	6.474	4.434	3.074	2.102	1.374	0.807	0.354

 S3P3W

ΔV (%)	1	2	3	4	5	6	7	8	9	10
Vout (V)	3.333	3.366	3.399	3.432	3.465	3.498	3.531	3.564	3.597	3.630
RU (k Ω)	57.930	26.165	15.577	10.283	7.106	4.988	3.476	2.341	1.459	0.753

 S05W

ΔV (%)	1	2	3	4	5	6	7	8	9	10
Vout (V)	5.050	5.100	5.150	5.200	5.250	5.300	5.350	5.400	5.450	5.500
RU (k Ω)	36.570	16.580	9.917	6.585	4.586	3.253	2.302	1.588	1.032	0.588

 S5P1W

ΔV (%)	1	2	3	4	5	6	7	8	9	10
Vout (V)	5.151	5.202	5.253	5.304	5.355	5.406	5.457	5.508	5.559	5.610
RU (k Ω)	38.135	17.368	10.446	6.985	4.908	3.524	2.535	1.793	1.217	0.755

 S12W

ΔV (%)	1	2	3	4	5	6	7	8	9	10
Vout (V)	12.120	12.240	12.360	12.480	12.600	12.720	12.840	12.960	13.080	13.200
RU (k Ω)	367.908	165.954	98.636	64.977	44.782	31.318	21.701	14.488	8.879	4.391

 S15W

ΔV (%)	1	2	3	4	5	6	7	8	9	10
Vout (V)	15.150	15.300	15.450	15.600	15.750	15.900	16.050	16.200	16.350	16.500
RU (k Ω)	404.184	180.592	106.061	68.796	46.437	31.531	20.883	12.898	6.687	1.718

OUTPUT VOLTAGE ADJUSTMENT(CONTINUED)

Trim-down

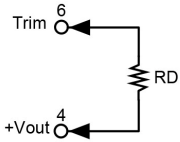

□□S1P5W

ΔV (%)	1	2	3	4	5	6	7	8	9	10
Vout (V)	1.485	1.470	1.455	1.440	1.425	1.410	1.395	1.380	1.365	1.350
RD (k Ω)	5.704	2.571	1.527	1.005	0.692	0.483	0.334	0.222	0.135	0.065

□□S2P5W

ΔV (%)	1	2	3	4	5	6	7	8	9	10
Vout (V)	2.475	2.450	2.425	2.400	2.375	2.350	2.325	2.300	2.275	2.250
RD (k Ω)	49.641	22.481	13.428	8.902	6.186	4.375	3.082	2.112	1.358	0.754

□□S3P3W

ΔV (%)	1	2	3	4	5	6	7	8	9	10
Vout (V)	3.267	3.234	3.201	3.168	3.135	3.102	3.069	3.036	3.003	2.970
RD (k Ω)	69.470	31.235	18.490	12.117	8.294	5.745	3.924	2.559	1.497	0.647

□□S05W

ΔV (%)	1	2	3	4	5	6	7	8	9	10
Vout (V)	4.950	4.900	4.850	4.800	4.750	4.700	4.650	4.600	4.550	4.500
RD (k Ω)	45.533	20.612	12.306	8.152	5.660	3.999	2.812	1.922	1.230	0.676

□□S5P1W

ΔV (%)	1	2	3	4	5	6	7	8	9	10
Vout (V)	5.049	4.998	4.947	4.896	4.845	4.794	4.743	4.692	4.641	4.590
RD (k Ω)	47.191	21.431	12.844	8.551	5.975	4.258	3.031	2.111	1.396	0.823

□□S12W

ΔV (%)	1	2	3	4	5	6	7	8	9	10
Vout (V)	11.880	11.760	11.640	11.520	11.400	11.280	11.160	11.040	10.920	10.800
RD (k Ω)	460.992	207.946	123.597	81.423	56.118	39.249	27.199	18.162	11.132	5.509

□□S15W

ΔV (%)	1	2	3	4	5	6	7	8	9	10
Vout (V)	14.850	14.700	14.550	14.400	14.250	14.100	13.950	13.800	13.650	13.500
RD (k Ω)	499.816	223.408	131.272	85.204	57.563	39.136	25.974	16.102	8.424	2.282