



P-DUKE POWER

MPD30 · MPD30W Series

DC-DC Converter
Up to 30 Watts

5
YEARS
WARRANTY

ROHS
COMPLIANT

REACH
COMPLIANT



Medical



PV



Automation



Datacom



IPC



Industry



Measurement



Telecom



Automobile



Boat



Charger



Railway

UL US CB CE FCC

2 x MOPP	5000 VAC Reinforced Insulation	4 : 1 Wide Input Range	2 : 1 Input Range	Internal EN55032 Class A Filter	LOW Leakage Current	LOW Standby Power	NO Min. Load Required	Operating Altitude 5000 meter	REMOTE ON OFF	OCP	OTP
OVP	SCP	UVP									

PART NUMBER STRUCTURE

MPD30 -	48	S	05	W	-	P
Series Name	Input Voltage (VDC)	Output Quantity	Output Voltage (VDC)	Input Range		Remote On/Off Option
	12:9~18 24:18~36 48:36~75	S:Single	05:5 12:12 15:15 24:24	□: 2:1		□:No pin P:Positive logic N:Negative logic
		D:Dual	05:±5 12:±12 15:±15			
	24:9~36 48:18~75	S:Single	05:5 12:12 15:15 24:24	W: 4:1		□:No pin P:Positive logic N:Negative logic
		D:Dual	05:±5 12:±12 15:±15			

TECHNICAL SPECIFICATION All specifications are typical at nominal input, full load and 25°C unless otherwise noted

Model Number	Input Range	Output Voltage	Output Current @Full Load	Input Current @ No Load	Efficiency	Maximum Capacitor Load
	VDC	VDC	A	mA	%	μF
MPD30-12S05	9 ~ 18	5	6	9	88.5	7200
MPD30-12S12	9 ~ 18	12	2.5	10	88.5	1200
MPD30-12S15	9 ~ 18	15	2	12	89.5	1000
MPD30-12S24	9 ~ 18	24	1.25	11	89	375
MPD30-12D05	9 ~ 18	±5	±3	13	86	±3600
MPD30-12D12	9 ~ 18	±12	±1.25	11	88.5	±750
MPD30-12D15	9 ~ 18	±15	±1	13	89	±500
MPD30-24S05	18 ~ 36	5	6	8	88.5	7200
MPD30-24S12	18 ~ 36	12	2.5	10	89	1200
MPD30-24S15	18 ~ 36	15	2	9	90.5	1000
MPD30-24S24	18 ~ 36	24	1.25	9	89.5	375
MPD30-24D05	18 ~ 36	±5	±3	10	86	±3600
MPD30-24D12	18 ~ 36	±12	±1.25	9	90	±750
MPD30-24D15	18 ~ 36	±15	±1	10	90	±500
MPD30-48S05	36 ~ 75	5	6	8	89	7200
MPD30-48S12	36 ~ 75	12	2.5	9	89	1200
MPD30-48S15	36 ~ 75	15	2	8	90	1000
MPD30-48S24	36 ~ 75	24	1.25	9	89	375
MPD30-48D05	36 ~ 75	±5	±3	9	86.5	±3600
MPD30-48D12	36 ~ 75	±12	±1.25	9	90	±750
MPD30-48D15	36 ~ 75	±15	±1	8	89.5	±500
MPD30-24S05W	9 ~ 36	5	6	9	88.5	7200
MPD30-24S12W	9 ~ 36	12	2.5	10	89	1200
MPD30-24S15W	9 ~ 36	15	2	10	90.5	1000
MPD30-24S24W	9 ~ 36	24	1.25	10	89.5	375
MPD30-24D05W	9 ~ 36	±5	±3	10	86	±3600
MPD30-24D12W	9 ~ 36	±12	±1.25	10	89.5	±750
MPD30-24D15W	9 ~ 36	±15	±1	9	90	±500
MPD30-48S05W	18 ~ 75	5	6	8	89	7200
MPD30-48S12W	18 ~ 75	12	2.5	9	89	1200
MPD30-48S15W	18 ~ 75	15	2	8	90	1000
MPD30-48S24W	18 ~ 75	24	1.25	9	89	375
MPD30-48D05W	18 ~ 75	±5	±3	9	86.5	±3600
MPD30-48D12W	18 ~ 75	±12	±1.25	9	90	±750
MPD30-48D15W	18 ~ 75	±15	±1	8	89.5	±500

INPUT SPECIFICATIONS

Parameter	Conditions		Min.	Typ.	Max.	Unit
Operating input voltage range	2:1	12Vin(nom)	9	12	18	VDC
		24Vin(nom)	18	24	36	
		48Vin(nom)	36	48	75	
	(W) 4:1	24Vin(nom)	9	24	36	VDC
		48Vin(nom)	18	48	75	
Start up voltage	2:1	12Vin(nom)			9	VDC
		24Vin(nom)			18	
		48Vin(nom)			36	
	(W) 4:1	24Vin(nom)			9	VDC
		48Vin(nom)			18	
Shutdown voltage	2:1	12Vin(nom)	7.8	8	8.6	VDC
		24Vin(nom)	15.8	16	17.4	
		48Vin(nom)	32	33	34	
	(W) 4:1	24Vin(nom)	7.8	8	8.6	VDC
		48Vin(nom)	15.8	16	17.4	
Start up time	Constant resistive load	Power up		30	60	ms
		Remote ON/OFF		30	60	
Input surge voltage	3 second, max.	12Vin(nom)			25	VDC
		24Vin(nom)			50	
		48Vin(nom)			100	
	3 second, max.	24Vin(nom)			50	VDC
		48Vin(nom)			100	
Input filter				Pi type		
Remote ON/OFF (Option)	Referred to - Vin pin	Positive logic	DC-DC ON	Open or 3.5 ~ 12VDC		
			DC-DC OFF	Short or 0 ~ 1.2VDC		
		Negative logic	DC-DC ON	Short or 0 ~ 1.2VDC		
			DC-DC OFF	Open or 3.5 ~ 12VDC		
		Input current of Ctrl pin	-0.5		1	mA
		Remote off input current		2.5		mA

OUTPUT SPECIFICATIONS

Parameter	Conditions		Min.	Typ.	Max.	Unit
Voltage accuracy			-1.0		+1.0	%
Line regulation	Low Line to High Line at Full Load	Single	-0.2		+0.2	%
		Dual	-0.5		+0.5	
Load regulation	No Load to Full Load	Single	-0.2		+0.2	%
		Dual	-1.0		+1.0	
Cross regulation	Asymmetrical load 25%/100% FL	Dual	-5.0		+5.0	%
Voltage adjustability	Single output	5Vout, 12Vout	-10		+10	%
		15Vout, 24Vout	-10		+20	
Ripple and noise	Measured by 20MHz bandwidth					mVp-p
		Single				
	With a 10μF/25V X7R MLCC	5Vout		50		
	With a 10μF/25V X7R MLCC	12Vout		75		
	With a 10μF/25V X7R MLCC	15Vout		100		
	With a 4.7μF/50V X7R MLCC	24Vout		100		
		Dual				
	With a 10μF/25V X7R MLCC	±5Vout		50		
With a 10μF/25V X7R MLCC	±12Vout		75			
With a 10μF/25V X7R MLCC	±15Vout		75			
Temperature coefficient			-0.02		+0.02	%/°C
Transient response recovery time	25% load step change			250		μs
Over voltage protection	Zener diode clamp	5Vout		6.2		VDC
		12Vout		15		
		15Vout		20		
		24Vout		30		
Over load protection	% of lout rated; Hiccup mode			150	185	%
Short circuit protection				Continuous, automatics recovery		

GENERAL SPECIFICATIONS

Parameter	Conditions	Min.	Typ.	Max.	Unit
Isolation voltage	1 minute Input to Output Reinforced insulation for 250VAC working voltage	5000			VAC
Isolation resistance	500VDC	10			GΩ
Isolation capacitance			20		pF
Leakage current	240VAC,60Hz		2	2.5	μA
Switching frequency		225	250	285	kHz
Clearance / Creepage		8			mm
Safety approvals	IEC/ EN/ ANSI/AAMI ES 60601-1 IEC/ EN/ UL 60950-1, 62368-1				UL:E360199 UL:E193009 CB:UL(Demko)
Case material					Non-conductive black plastic
Base material					Non-conductive black plastic
Potting material					Silicone (UL94 V-0)
Weight					32g (1.13oz)
MTBF	MIL-HDBK-217F, Full load				1.137×10 ⁶ hrs

ENVIRONMENTAL SPECIFICATIONS

Parameter	Conditions	Min.	Typ.	Max.	Unit
Operating ambient temperature	With derating	-40		+105	°C
Maximum case temperature				105	°C
Over temperature protection			115		°C
Storage temperature range		-55		+125	°C
Thermal impedance			12.85		°C/W
Operating altitude				5000	m
Thermal shock					MIL-STD-810F
Vibration					MIL-STD-810F
Relative humidity					5% to 95% RH

EMC SPECIFICATIONS

Parameter	Conditions	Level
EMI	EN55011,EN55032 and FCC Part 18 Without external components. With external components.	Class A Class B
ESD	EN61000-4-2 Air ± 15kV and Contact ± 8kV	Perf. Criteria A
Radiated immunity	EN61000-4-3 10 V/m	Perf. Criteria A
Fast transient	EN61000-4-4 ± 2kV	Perf. Criteria A
	MPD30-12□□□□ With 2 pcs of aluminum electrolytic capacitor (Nippon chemi-con KY series, 220μF/100V) and a TVS (SMDJ36A, 36V, 3000 Watt peak pulse power) in parallel.	
	MPD30-24□□□□ With 2 pcs of aluminum electrolytic capacitor (Nippon chemi-con KY series, 220μF/100V) and a TVS (SMDJ58A, 58V, 3000 Watt peak pulse power) in parallel.	
	MPD30-48□□□□ With 2 pcs of aluminum electrolytic capacitor (Nippon chemi-con KY series, 220μF/100V) and a TVS (SMDJ120A, 120V, 3000 Watt peak pulse power) in parallel.	

EMC SPECIFICATIONS(CONTINUED)

Parameter	Conditions	Level
Surge	EN61000-4-5 ± 2kV MPD30-12□□□□ With 2 pcs of aluminum electrolytic capacitor (Nippon chemi-con KY series, 220μF/100V) and a TVS (SMDJ36A, 36V, 3000 Watt peak pulse power) in parallel. MPD30-24□□□□ With 2 pcs of aluminum electrolytic capacitor (Nippon chemi-con KY series, 220μF/100V) and a TVS (SMDJ58A, 58V, 3000 Watt peak pulse power) in parallel. MPD30-48□□□□ With 2 pcs of aluminum electrolytic capacitor (Nippon chemi-con KY series, 220μF/100V) and a TVS (SMDJ120A, 120V, 3000 Watt peak pulse power) in parallel.	Perf. Criteria A
Conducted immunity	EN61000-4-6 10 Vr.m.s	Perf. Criteria A
Power frequency magnetic field	EN61000-4-8 100A/m continuous; 1000A/m 1 second	Perf. Criteria A

CAUTION: This power module is not internally fused. An input line fuse must always be used.

CHARACTERISTIC CURVE

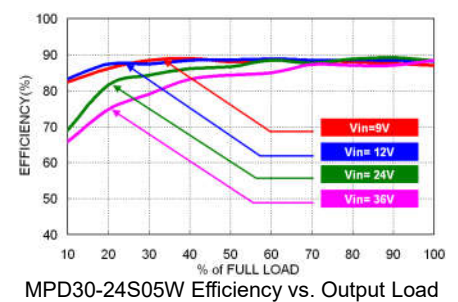
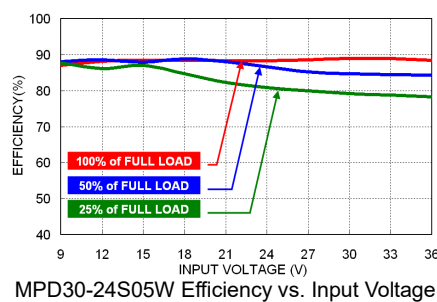
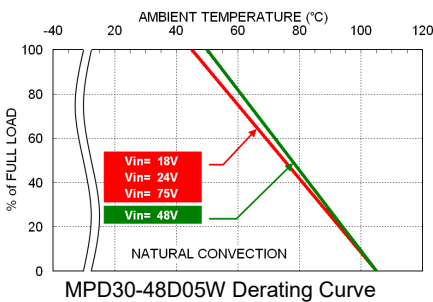
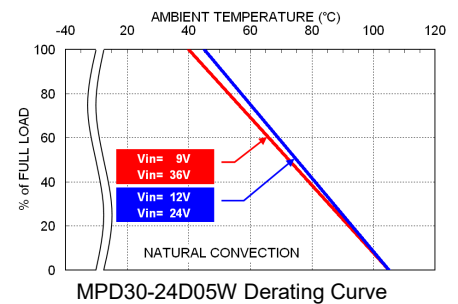
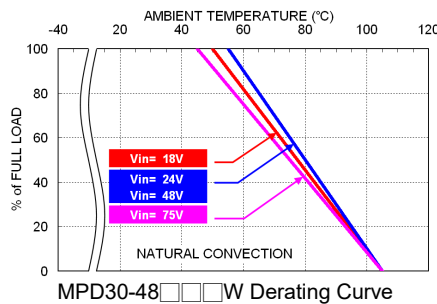
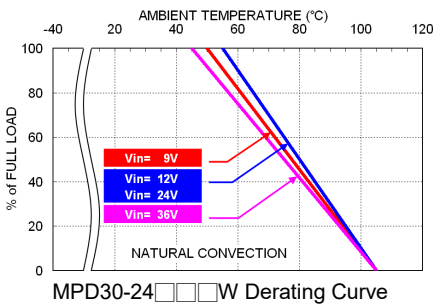

FUSE CONSIDERATION

This power module is not internally fused. An input line fuse must always be used.

This encapsulated power module can be used in a wide variety of applications, ranging from simple stand-alone operation to an integrated part of sophisticated power architecture.

To maximum flexibility, internal fusing is not included; however, to achieve maximum safety and system protection, always use an input line fuse.

The input line fuse suggest as below :

Model	Fuse Rating (A)	Fuse Type
MPD30-12□□□□ - 24□□□□W	6.3	Slow-Blow
MPD30-24□□□□ - 48□□□□W	3.15	Slow-Blow
MPD30-48□□□□	1.6	Slow-Blow

The table based on the information provided in this data sheet on inrush energy and maximum DC input current at low Vin.

MECHANICAL DRAWING

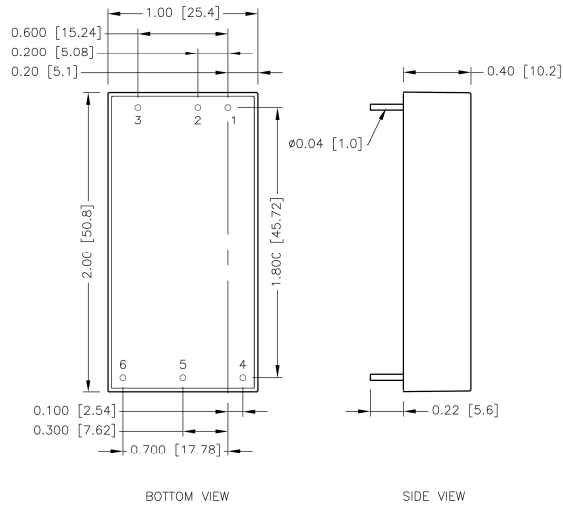

PIN CONNECTION

PIN	SINGLE	DUAL
1	+Vin	+Vin
2	-Vin	-Vin
3	Ctrl (Option)	Ctrl (Option)
4	+Vout	+Vout
5	-Vout	Common
6	Trim	-Vout

- All dimensions in inch [mm]
- Tolerance :x.xx±0.02 [x.x±0.5]
x.xxx±0.010 [x.xx±0.25]
- Pin dimension tolerance ±0.004[0.10]

RECOMMENDED PAD LAYOUT

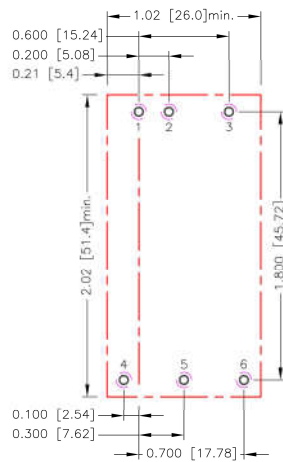

All dimensions in inch[mm]
 Pad size(lead free recommended)
 Through hole 1.2.3.4.5.6: $\phi 0.051$ [1.30]
 Top view pad 1.2.3.4.5.6: $\phi 0.064$ [1.63]
 Bottom view pad 1.2.3.4.5.6: $\phi 0.102$ [2.60]

- * There should be at least 8mm distance between primary and secondary circuit.
- ** For further information, please contact P-DUKE.

THERMAL CONSIDERATIONS

The power module operates in a variety of thermal environments.

However, sufficient cooling should be provided to help ensure reliable operation of the unit.

Heat is removed by conduction, convection, and radiation to the surrounding Environment.

Proper cooling can be verified by measuring the point as the figure below.

The temperature at this location should not exceed "Maximum case temperature".

When Operating, adequate cooling must be provided to maintain the test point temperature at or below "Maximum case temperature".

You can limit this Temperature to a lower value for extremely high reliability.

- Thermal test condition with vertical direction by natural convection (20LFM).

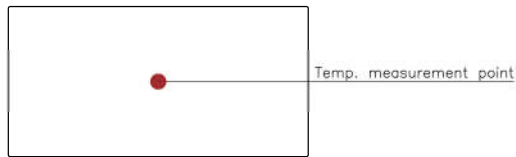

TOP VIEW

OUTPUT VOLTAGE ADJUSTMENT

It allows the user to increase or decrease the output voltage of the module.

This is accomplished by connecting an external resistor between the Trim pin and either the +Vout or -Vout pins.

With an external resistor between the Trim and -Output pin, the output voltage increases.

With an external resistor between the Trim and +Output pin, the output voltage decreases.

The external Trim resistor needs to be at least 1/16W of rated power.

Trim Up Equation

$$R_U = \left[\frac{G \times L}{(V_{o,up} - L - K)} - H \right] \Omega$$

Trim Down Equation

$$R_D = \left[\frac{(V_{o,down} - L) \times G}{(V_o - V_{o,down})} - H \right] \Omega$$

Trim Constants

Module	G	H	K	L
MPD30-□□S05、□□S05W	5110	2050	2.5	2.5
MPD30-□□S12、□□S12W	10000	5110	9.5	2.5
MPD30-□□S15、□□S15W	10000	5110	12.5	2.5
MPD30-□□S24、□□S24W	56000	13000	21.5	2.5

EXTERNAL OUTPUT TRIMMING

Output can be externally trimmed by using the method shown below.

Trim-up

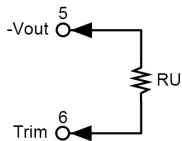

□□S05、□□S05W

ΔV (%)	1	2	3	4	5	6	7	8	9	10
Vout (V)	5.05	5.1	5.15	5.2	5.25	5.3	5.35	5.4	5.45	5.5
R _U (kΩ)	253.450	125.700	83.117	61.825	49.050	40.533	34.450	29.888	26.339	23.500

□□S12、□□S12W

ΔV (%)	1	2	3	4	5	6	7	8	9	10
Vout (V)	12.12	12.24	12.36	12.48	12.6	12.72	12.84	12.96	13.08	13.2
R _U (kΩ)	203.223	99.057	64.334	46.973	36.557	29.612	24.652	20.932	18.038	15.723

□□S15、□□S15W

ΔV (%)	1	2	3	4	5	6	7	8	9	10
Vout (V)	15.15	15.3	15.45	15.6	15.75	15.9	16.05	16.2	16.35	16.5
R _U (kΩ)	161.557	78.223	50.446	36.557	28.223	22.668	18.700	15.723	13.409	11.557

ΔV (%)	11	12	13	14	15	16	17	18	19	20
Vout (V)	16.65	16.8	16.95	17.1	17.25	17.4	17.55	17.7	17.85	18
R _U (kΩ)	10.042	8.779	7.711	6.795	6.001	5.307	4.694	4.149	3.662	3.223

□□S24、□□S24W

ΔV (%)	1	2	3	4	5	6	7	8	9	10
Vout (V)	24.24	24.48	24.72	24.96	25.2	25.44	25.68	25.92	26.16	26.4
R _U (kΩ)	570.333	278.667	181.444	132.833	103.667	84.222	70.333	59.917	51.815	45.333

ΔV (%)	11	12	13	14	15	16	17	18	19	20
Vout (V)	26.64	26.88	27.12	27.36	27.6	27.84	28.08	28.32	28.56	28.8
R _U (kΩ)	40.030	35.611	31.872	28.667	25.889	23.458	21.314	19.407	17.702	16.167

OUTPUT VOLTAGE ADJUSTMENT(CONTINUED)

Trim-down

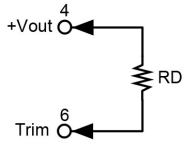

□□S05W										
ΔV (%)	1	2	3	4	5	6	7	8	9	10
Vout (V)	4.95	4.9	4.85	4.8	4.75	4.7	4.65	4.6	4.55	4.5
RD (k Ω)	248.340	120.590	78.007	56.715	43.940	35.423	29.340	24.778	21.229	18.390

□□S12W										
ΔV (%)	1	2	3	4	5	6	7	8	9	10
Vout (V)	11.88	11.76	11.64	11.52	11.4	11.28	11.16	11.04	10.92	10.8
RD (k Ω)	776.557	380.723	248.779	182.807	143.223	116.834	97.985	83.848	72.853	64.057

□□S15W										
ΔV (%)	1	2	3	4	5	6	7	8	9	10
Vout (V)	14.85	14.7	14.55	14.4	14.25	14.1	13.95	13.8	13.65	13.5
RD (k Ω)	818.223	401.557	262.668	193.223	151.557	123.779	103.938	89.057	77.483	68.223

□□S24W										
ΔV (%)	1	2	3	4	5	6	7	8	9	10
Vout (V)	23.76	23.52	23.28	23.04	22.8	22.56	22.32	22.08	21.84	21.6
RD (k Ω)	4947.667	2439.333	1603.222	1185.167	934.333	767.111	647.667	558.083	488.407	432.667