

RRD-S/D06W

6W Regulated Single & Dual Output DC/DC Converter



Picture similar



- 24 Pin DIL Package
- Wide 4:1 Input Range
- 1500 or 3000VDC Isolation
- EMI filter meets EN55032 class A without external components
- Efficiency up to 85%
- Operating Temperature Range -40°C ~ +85°C
- Continuous Short Circuit Protection
- Over Current Protection, Under Voltage Protection
- Plastic Case

Output Specifications	
Voltage Accuracy	±2%, max.
Output Voltage Adjustability (Trim)	–
Maximum Output Current	See table
Line Regulation	Single & Dual ±0.5% max.
Load Regulation	from 0% to 100% Load: ±1.2% max.
Cross Regulation (Dual Output)	±5%
Over Voltage Protection	–
Over Current Protection	160% of I _{out} typ.
Short Circuit Protection	Indefinite (Automatic Recovery)
Ripple & Noise (20 MHz bandwidth)	80 ~ 100mV pk-pk max.
Temperature Coefficient	±0.02%/°C
Capacitor Load	See table
Transient Recovery Time	300µs typ.
Transient Response	(Deviation) ±3 ~ 5% max.

Input Specifications	
Voltage Range	See table
Start-up Time	20ms typ.
No-Load/Full-Load Input Current	See table
Input Filter	C/L (see filter details on following pages)
Input Reflected Ripple Current	20mA pk-pk typ.
Remote ON	–
Remote OFF	–
OFF Stand By Current	–
OFF Idle Current	–

General Specifications	
Efficiency	See table typ.
I/O Isolation Voltage (60 sec)	1500 ~ 3000VDC
Isolation Voltage Metal Case/Input&Output	–
I/O Isolation Capacitance	1000pF typ.
I/O Isolation Resistance	1000M Ohm, min
Switching Frequency	330kHz typ.
Humidity	95% rel H
Reliability Calculated MTBF	>800Khrs (MIL-HDBK-217 f)
Safety Standard(s)	UL60950-1 (approval), UL62368-1 (meet)

Environmental Specifications	
Operating Temperature Range	-40°C ~ +85°C (see Derating Curve)
Maximum Case Temperature	100°C
Storage Temperature	-55°C ~ +125°C
Cooling	Natural Convection

Physical Specifications	
Case Material	Non-conductive Black Plastic (UL94V-0 rated)
Pin Material	0.5mm Brass Solder-coated
Potting Material	Epoxy (UL94V-0 rated)
Weight	13.0g
Case Dimensions	1.25" x 0.80" x 0.40"

Absolute Maximum Ratings (1)	
Input Surge Voltage (100 ms)	
24V Models	50VDC max.
48V Models	100VDC max.
Soldering Temperature (2)	260°C max.

EMC Specifications	
Radiated / Conducted Emissions	EN55032 Class A see EMI Filter
ESD	IEC 61000-4-2 Perf.Criteria A
RS	IEC 61000-4-3 Perf.Criteria A
EFT	IEC 61000-4-4 Perf.Criteria A
SURGE	IEC 61000-4-5 Perf.Criteria A
CS	IEC 61000-4-6 Perf.Criteria A
PFMF or Voltage Dip/Drop/Interruption	IEC 61000-4-8 Perf.Criteria A

(1) These are stress ratings. Exposure of devices to any of these conditions may adversely affect long-term reliability. (2) 1.5 mm from case 10 sec max.

All specifications typical at TA = 25 °C, nominal input voltage and full load unless otherwise specified.

The information and specification contained in this data sheet are believed to be correct at time of publication. However RSG accepts no responsibility for consequences arising from printing errors or inaccuracies. **Specifications are subject to change without notice.**

Number structure RRD Series

RRD	–	48	12	S	06	A	3	(W)
Name / package	V-input nom.	V-output	Output type	Power	Int. Code	Isolation (VDC)	Wide-Input	
RRD = DIL24	12 = 9V~18V 24 = 18V~36V or 9V~36V 48 = 36V~75V or 18V~75V	03 = 3.3V 05 = 5V ...	S = Single D = Dual	03 = 3.0W 06 = 6.0W	Logistics Code	1 = 1.5k 3 = 3.0k	_ = 2:1 W = 4:1	

Derating Curve

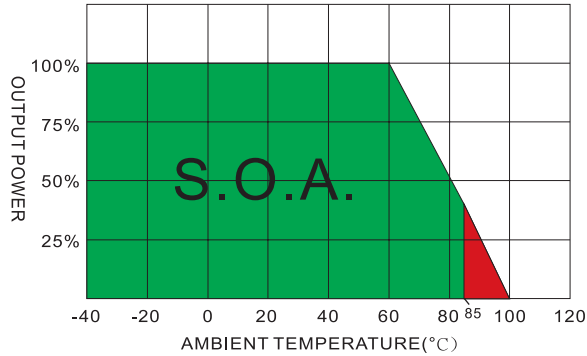

Model Selection Guide

Suffix X = 1 means 1.5 kV DC and X = 3 means 3.0 kV DC Isolation Voltage

Model Number	Input Voltage Range (VDC)	Input Current		Output Voltage (VDC)	Output Current		Efficiency @Full Load (%, typ.)	Capacitor Load @Full Load (µF, max.)
		No-Load (mA, max.)	Full Load (mA, typ.)		Min. Load (mA)	Full Load (mA)		
RRD-2403S06AXW	9-36	10	257	3.3	0	1400	76	470
RRD-2405S06AXW	9-36	10	316	5	0	1200	80	470
RRD-2412S06AXW	9-36	10	301	12	0	500	84	100
RRD-2415S06AXW	9-36	10	301	15	0	400	84	100
RRD-2424S06AXW	9-36	10	301	24	0	250	84	47
RRD-2403D06AXW	9-36	10	325	±3.3	0	±909	78	±220
RRD-2405D06AXW	9-36	10	309	±5	0	±600	82	±220
RRD-2412D06AXW	9-36	10	301	±12	0	±250	84	±100
RRD-2415D06AXW	9-36	15	301	±15	0	±200	84	±100
RRD-2424D06AXW	9-36	20	309	±24	0	±125	82	±47
RRD-4803S06AXW	18-75	7	128	3.3	0	1400	76	470
RRD-4805S06AXW	18-75	7	154	5	0	1200	82	470
RRD-4812S06AXW	18-75	7	151	12	0	500	84	100
RRD-4815S06AXW	18-75	7	149	15	0	400	85	100
RRD-4824S06AXW	18-75	7	149	24	0	250	85	47
RRD-4803D06AXW	18-75	7	160	±3.3	0	±909	79	±220
RRD-4805D06AXW	18-75	7	154	±5	0	±600	82	±220
RRD-4812D06AXW	18-75	7	151	±12	0	±250	84	±100
RRD-4815D06AXW	18-75	7	151	±15	0	±200	84	±100
RRD-4824D06AXW	18-75	10	156	±24	0	±125	81	±47

The models listed above are standard types. If you need special specifications or have questions regarding packing (Tube or Tape & Reel) or need application support, please contact our specialists: sales@rsg-electronic.de or +49 69-984047-0

Test Configurations

Input Reflected Ripple Current Test Step

Input reflected ripple current is measured through a source inductor L_{in} (12µH) and a source capacitor C_{in} (47µF, ESR<1.0Ω at 100KHz) at nominal input and full load.

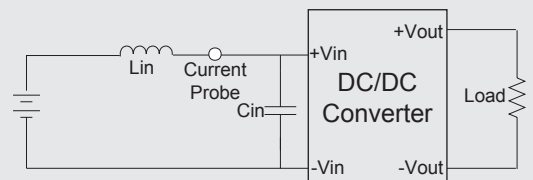

Test Configurations

Output Ripple & Noise Measurement Test

Use a capacitor C_{out} (1.0 μ F) measurement.
The Scope measurement bandwidth is 0~20 MHz.

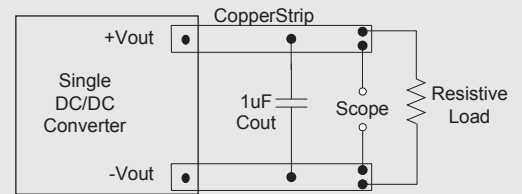

Electrical Characteristic Curves

RRD-2403D06AXW
Efficiency vs Output Current

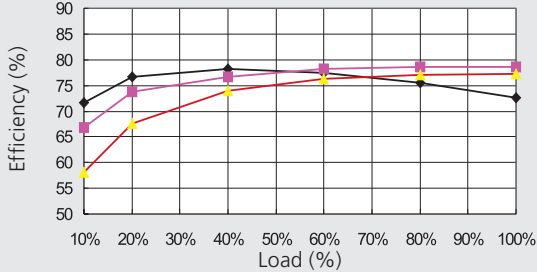

RRD-2424S06AXW
Efficiency vs Output Current

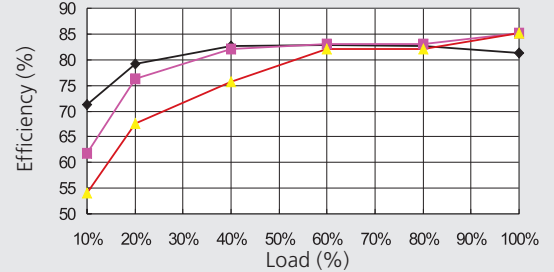

RRD-4805S06AXW
Efficiency vs Output Current

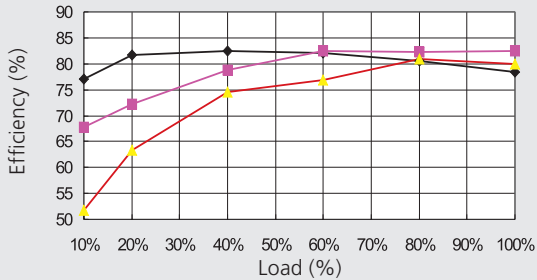

RRD-4824D06AXW
Efficiency vs Output Current

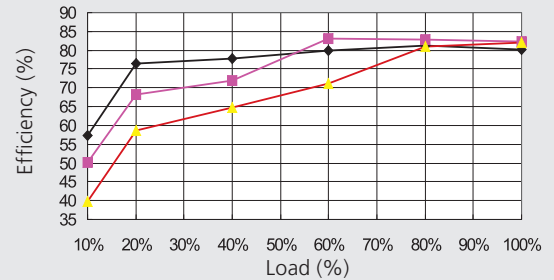

◆ Lo Line ■ Nominal Line ▲ Hi Line

Mechanical Specifications

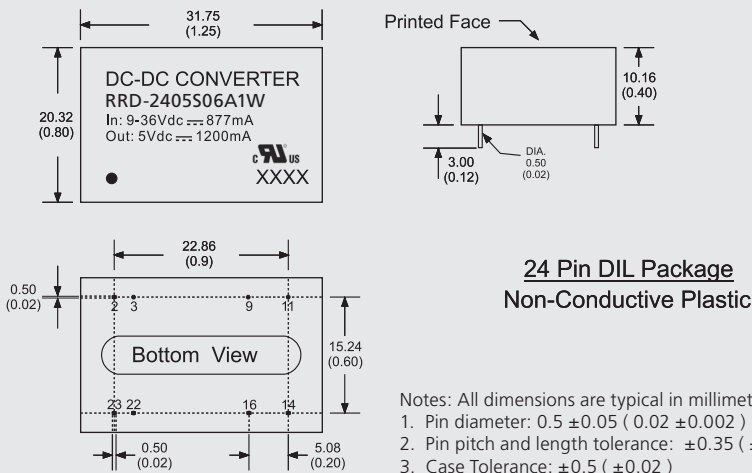

Pin Connections

Pin Number	Single	Dual
2	-V Input	-V Input
3	-V Input	-V Input
9	N. P.	Common
11	N. C.	-V Output
14	+V Output	+V Output
16	-V Output	Common
22	+V Input	+V Input
23	+V Input	+V Input

(Pin-out is identical for standard and high isolation models.)

Note:

- Cross regulation: one load is 25% to 100% load, the other load is 100% load, the output voltage variable rate is within $\pm 5\%$.
- Ripple/Noise measured with a 1μ F ceramic capacitor.
- Capacitive load is tested at minimal V_{in} and constant resistive load.
- Transient recovery and response are tested at normal V_{in} and 25% load step change (75%-50%-25% of I_o).
- Measured Input reflected ripple current with a simulated source inductance of 12μ H and a source capacitor C_{in} (47μ F, $ESR < 1.0\Omega$ at 100kHz).
- An external filter capacitor is required if the module has to meet IEC61000-4-5. The suggested filter capacitor: Nippon chemi-con KY series, 220μ F/100V.
- Exceeding the absolute ratings of the unit could cause damage. It is not allowed for continuous operating.